

Características
Técnicas

AT















HASTA EL

25% DE
DESCUENTO



ARMARIOS

- Estantes incorporados de 25 mm. de espesor.
- Cantos rectos de 2 mm. de grosor.
- Aristas redondeadas.
- Bisagras provistas de sistema autocierre y apertura a 110°.
- Puertas provistas de falleba.
- Archivos con guías telescópicas de extracción total con cerradura individualizada en cada cajón y llave maestra para ambos cajones.
- Tableros aglomerados de alta densidad, $\pm 750 \text{ Kg/m}^3$.
- Vitrinas con cristales al ácido de 5 mm. de espesor.
- Niveladores de 1,5 cm. de regulación, regulables desde el interior.







		ACABADO MADERA	PVP	ACABADO ESTRATIFICADO	PVP			ACABADO MADERA	PVP	ACABADO ESTRATIFICADO	PVP				
		CEREZO	HAYA	€	WENGUE NOGAL	ROBLE	ZEBRANO	€	CEREZO	HAYA	€	WENGUE NOGAL	ROBLE	ZEBRANO	€
MEDIDAS															
alto x ancho x fondo															
74 x 90 x 45 - CON 1 ESTANTE															
	A.VE3C	A.VE3H	170,57	A.VE3W	A.VE3N	A.VE3R	A.VE3Z	145,66							
74 x 90 x 45 - CON 1 ESTANTE															
	A.VB3C	A.VB3H	298,72	A.VB3W	A.VB3N	A.VB3R	A.VB3Z	239,40							
Puertas batientes															
74 x 90 x 45															
	A.VF3C	A.VF3H	509,62	A.VF3W	A.VF3N	A.VF3R	A.VF3Z	409,08							
Archivador															
74 x 90 x 45 - CON 1 ESTANTE															
	A.VC3C	A.VC3H	363,00	A.VC3W	A.VC3N	A.VC3R	A.VC3Z	303,67							
Puertas correderas															
160 x 90 x 45 - CON 3 ESTANTES															
	A.VE2C	A.VE2H	234,22	A.VE2W	A.VE2N	A.VE2R	A.VE2Z	209,31							
160 x 90 x 45 - CON 3 ESTANTES															
	A.VB2C	A.VB2H	362,37	A.VB2W	A.VB2N	A.VB2R	A.VB2Z	303,04							
Puertas batientes															
160 x 90 x 45 - CON 3 ESTANTES															
	A.VA2C	A.VA2H	417,45	A.VA2W	A.VA2N	A.VA2R	A.VA2Z	308,99							
Puertas batientes															
MEDIDAS															
alto x ancho x fondo															
160 x 90 x 45 - CON 2 ESTANTES															
	A.VF2C	A.VF2H	573,27	A.VF2W	A.VF2N	A.VF2R	A.VF2Z	472,74							
Archivador															
160 x 90 x 45 - CON 3 ESTANTES															
	A.VC2C	A.VC2H	426,65	A.VC2W	A.VC2N	A.VC2R	A.VC2Z	367,31							
Puertas correderas															
200 x 90 x 45 - CON 4 ESTANTES															
	A.VEC	A.VEH	302,19	A.VEW	A.VEN	A.VER	A.VEZ	277,28							
200 x 90 x 45 - CON 4 ESTANTES															
	A.VBC	A.VBH	430,34	A.VBW	A.VBN	A.VBR	A.VBZ	371,01							
Puertas batientes															
200 x 90 x 45 - CON 4 ESTANTES															
	A.VAC	A.VAH	525,54	A.VAW	A.VAN	A.VAR	A.VAZ	399,49							
Puertas batientes															
200 x 90 x 45 - CON 3 ESTANTES															
	A.VFC	A.VFH	641,23	A.VFW	A.VFN	A.VFR	A.VFZ	540,70							
Archivador															
200 x 90 x 45 - CON 4 ESTANTES															
	A.VCC	A.VCH	494,62	A.VCW	A.VCN	A.VCR	A.VCZ	435,28							
Puertas correderas															





MEDIDAS alto x ancho x fondo	CEREZO	HAYA	€	WENGUE	NOGAL	ROBLE	ZEBRANO	€
74 x 45 x 45 - CON 1 ESTANTE								
	A.VE3C/5	A.VE3H/5	121,45	A.VE3W/5	A.VE3N/5	A.VE3R/5	A.VE3Z/5	100,08
74 X 45 X 45 - CON 1 ESTANTE								
	A.VB3C/5I A.VB3C/5D	A.VB3H/5I A.VB3H/5D	204,32	A.VB3W/5I A.VB3W/5D	A.VB3N/5I A.VB3N/5D	A.VB3R/5I A.VB3R/5D	A.VB3Z/5I A.VB3Z/5D	159,21
160 X 45 X 45 - CON 3 ESTANTES								
	A.VE2C/5	A.VE2H/5	197,13	A.VE2W/5	A.VE2N/5	A.VE2R/5	A.VE2Z/5	175,76
160 X 45 X 45 - CON 3 ESTANTES								
	A.VB2C/5I A.VB2C/5D	A.VB2H/5I A.VB2H/5D	279,99	A.VB2W/5I A.VB2W/5D	A.VB2N/5I A.VB2N/5D	A.VB2R/5I A.VB2R/5D	A.VB2Z/5I A.VB2Z/5D	234,89
160 X 45 X 45 - CON 3 ESTANTES								
	A.VA2C/5I A.VA2C/5D	A.VA2H/5I A.VA2H/5D	333,00	A.VA2W/5I A.VA2W/5D	A.VA2N/5I A.VA2N/5D	A.VA2R/5I A.VA2R/5D	A.VA2Z/5I A.VA2Z/5D	251,11
200 X 45 X 45 - CON 4 ESTANTES								
	A.VEC/5	A.VEH/5	253,30	A.VEW/5	A.VEN/5	A.VER/5	A.VEZ/5	231,94
200 X 45 X 45 - CON 4 ESTANTES								
	A.VBC/5I A.VBC/5D	A.VBH/5I A.VBH/5D	336,16	A.VBW/5I A.VBW/5D	A.VBN/5I A.VBN/5D	A.VBR/5I A.VBR/5D	A.VBZ/5I A.VBZ/5D	291,07
200 X 45 X 45 - CON 4 ESTANTES								
	A.VAC/5I A.VAC/5D	A.VAH/5I A.VAH/5D	430,75	A.VAW/5I A.VAW/5D	A.VAN/5I A.VAN/5D	A.VAR/5I A.VAR/5D	A.VAZ/5I A.VAZ/5D	329,89
160 X 180 X 45 - CON 2 VITRINAS DE ALUMINIO DE 45 CM.								
	A.V160C	A.V160H	1112,29	A.V160W	A.V160N	A.V160R	A.V160Z	1034,55

ESTANTE DE ARMARIO DE 45 cm.								
	A.E45C	A.E45H	22,65	I.E45W	I.E45N	I.E45R	A.E45Z	22,65
ESTANTE DE ARMARIO DE 90 cm.								
	A.E90C	A.E90H	28,63	I.E90W	I.E90N	I.E90R	A.E90Z	28,63
ESTANTE DE ARMARIO DE 90 cm. PARA CARPETAS. NO VÁLIDO PARA ARMARIOS DE PUERTAS CORREDERAS								
	A.BASC	A.BASH	34,06	I.BASW	I.BASN	I.BASR	A.BASZ	34,06

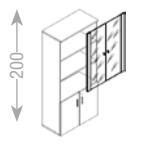
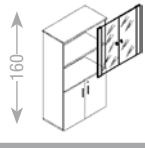
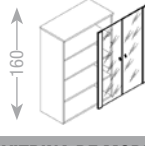
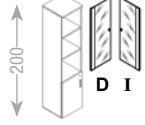
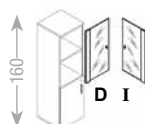
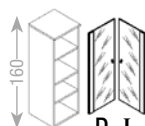
ESTAS ENCIMERAS SUSTITUYEN A LAS QUE LLEVAN LOS ARMARIOS DE SERIE								
ENCIMERA PARA 2 ARMARIOS: 135 cm. = 90 cm. + 45 cm.								
	A.ENC135C	A.ENC135H	0,00	I.ENC135W	I.ENC135N	I.ENC135R	A.ENC135Z	0,00
ENCIMERA PARA 2 ARMARIOS: 180 cm. = 90 cm. + 90 cm.								
	A.ENC180C	A.ENC180H	0,00	I.ENC180W	I.ENC180N	I.ENC180R	A.ENC180Z	0,00
ENCIMERA PARA 3 ARMARIOS: 225 cm. = 90 cm. + 45 cm. + 90 cm.								
	A.ENC225C	A.ENC225H	0,00	I.ENC225W	I.ENC225N	I.ENC225R	A.ENC225Z	0,00
ENCIMERA PARA 3 ARMARIOS: 270 cm. = 90 cm. + 90 cm. + 90 cm.								
	-	-	-	I.ENC270W	I.ENC270N	I.ENC270R	A.ENC270Z	0,00

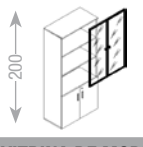
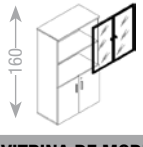
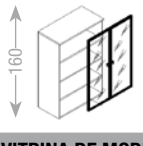
	ACABADO MADERA	PVP	ACABADO ESTRATIFICADO	PVP				
	CEREZO	HAYA	WENGUE	NOGAL	ROBLE	ZEBRANO	€	
JUEGO DE COSTADOS TERMINALES CON ASPA METÁLICA. medidas: 220 x 95 x 33								
	A.ESTT.C	A.ESTT.H	147,28	I.ESTT.W	I.ESTT.N	I.ESTT.R	A.ESTT.Z	147,28
GOSTADO INTERMEDIO CON ASPA. medidas: 220 x 92,5 x 33								
	A.ESTI.C	A.ESTI.H	83,15	I.ESTI.W	I.ESTI.N	I.ESTI.R	A.ESTI.Z	83,15
ESTANTE DE MÓDULO ESTANTERÍA. medidas: 90 x 31								
	A.EMEC	A.EMEH	36,37	I.EMEW	I.EMEN	I.EMER	A.EMEZ	36,37
ESTANTE METÁLICO DE MÓDULO ESTANTERÍA, GRIS ALUMINIO. Medidas: 90 x 31								
	I.EMET						44,25	

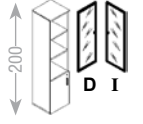
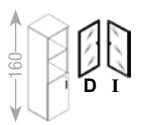
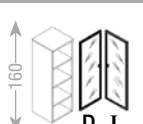
	ACABADO MADERA	PVP	ACABADO ESTRATIFICADO	PVP				
	CEREZO	HAYA	WENGUE	NOGAL	ROBLE	ZEBRANO	€	
VITRINA DE MODELOS VB-VF-VC MARCOS MADERA								
	A.VITBC	A.VITBH	228,59	I.VITBW	I.VITBN	I.VITBR	A.VITBZ	221,94
VITRINA DE MODELOS VB2-VF2-VC2 MARCOS MADERA								
	A.VITB2C	A.VITB2H	182,36	I.VITB2W	I.VITB2N	I.VITB2R	A.VITB2Z	177,02
VITRINA DE MODELOS VE2 MARCOS MADERA								
	A.VITE2C	A.VITE2H	228,59	I.VITE2W	I.VITE2N	I.VITE2R	A.VITE2Z	221,94
VITRINA DE MODELOS VB/5 MARCOS MADERA								
	A.VITBC/5I	A.VITBH/5I	132,71	I.VITBW/5I	I.VITBN/5I	I.VITBR/5I	A.VITBZ/5I	128,85
	A.VITBC/5D	A.VITBH/5D		I.VITBW/5D	I.VITBN/5D	I.VITBR/5D	A.VITBZ/5D	
VITRINA DE MODELOS VB2/5 MARCOS MADERA								
	A.VITB2C/5I	A.VITB2H/5I	109,60	I.VITB2W/5I	I.VITB2N/5I	I.VITB2R/5I	A.VITB2Z/5I	106,41
	A.VITB2C/5D	A.VITB2H/5D		I.VITB2W/5D	I.VITB2N/5D	I.VITB2R/5D	A.VITB2Z/5D	
VITRINA DE MODELOS VE2/5 MARCOS MADERA								
	A.VITE2C/5I	A.VITE2H/5I	132,71	I.VITE2W/5I	I.VITE2N/5I	I.VITE2R/5I	A.VITE2Z/5I	128,85
	A.VITE2C/5D	A.VITE2H/5D		I.VITE2W/5D	I.VITE2N/5D	I.VITE2R/5D	A.VITE2Z/5D	

	ALUMINIO	PVP
		€
VITRINAS CON CERRADURA		
VITRINA DE MODELOS VB-VF-VC MARCOS ALUMINIO		
	I.VITBML	332,67
VITRINA DE MODELOS VB2-VF2 MARCOS ALUMINIO		
	I.VITB2ML	256,55
VITRINA DE MODELOS VE2 MARCOS ALUMINIO		
	I.VITE2ML	368,26
VITRINA DE MODELOS VE3 MARCOS ALUMINIO		
	I.VITE3ML	256,55
VITRINA DE MODELOS VB/5 MARCOS ALUMINIO		
	I.VITBML/5I	166,33
	I.VITBML/5D	
VITRINA DE MODELOS VB2/5 MARCOS ALUMINIO		
	I.VITB2ML/5I	128,26
	I.VITB2ML/5D	
VITRINA DE MODELOS VE2/5 MARCOS ALUMINIO		
	I.VITE2ML/5I	184,14
	I.VITE2ML/5D	
VITRINA DE MODELOS VE3/5 MARCOS ALUMINIO		
	I.VITE3ML/5I	128,26
	I.VITE3ML/5D	

Características Técnicas

ARMARIOS

- Encimeras, frentes y costados fabricados con tableros de M.D.F. de 19 mm. de espesor y densidad de $\pm 950 \text{ kg/m}^3$.
- Cantos biselados en tres ejes y lacados a tono.
- Estantes incorporados de 25 mm. de espesor.
- Puertas provistas de bisagras super acodadas, que permiten salvar el bisel del costado para posteriormente abrir la puerta hasta un ángulo de 110° . Bisagras regulables en altura y profundidad con parada de seguridad.
- Archivos con guías telescópicas de extracción total con cerradura individualizada en cada cajón y llave maestra para ambos cajones.
- Estanterías fabricadas con tablero atamborado de 60 mm. de espesor con el interior formado por tablero aglomerado de 10 mm. de espesor en ambas caras y una plancha de 40 mm. de espesor de espuma rígida de poliestireno.
- Vitrinas con cristales al ácido de 5 mm. de espesor.
- Niveladores de 1,5 cm. de regulación, regulables desde el interior.

BLOCK



e=19 mm.

CANTO BISELADO - TABLERO M.D.F.

PVP

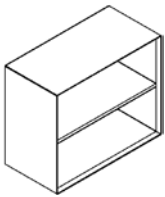
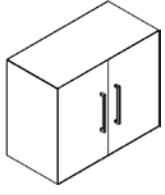
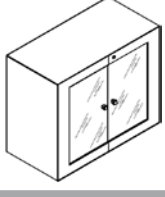
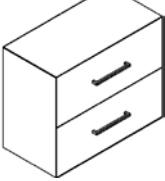
ARMARIOS INDIVIDUALES				
MEDIDAS alto x ancho x fondo	WENGUE	NOGAL	ARCE	€
74 x 89 x 45	Armario en M.D.F. con 1 estante			
	B.VE3W	B.VE3N	B.VE3A	298,95
74 x 89 x 45	Armario en M.D.F. con puertas y 1 estante			
	B.VB3W	B.VB3N	B.VB3A	481,72
74 x 89 x 45	Armario en M.D.F. con vitrinas y 1 estante			
	B.W3W	B.W3N	B.W3A	561,88
74 x 89 x 45	Armario en M.D.F. con 2 archivadores			
	B.VF3W	B.VF3N	B.VF3A	620,38

PVP

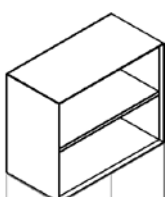
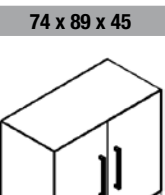
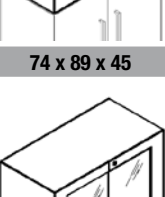
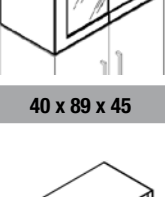
ARMARIOS DE PROLONGACIÓN				
MEDIDAS alto x ancho x fondo	WENGUE	NOGAL	ARCE	€
74 x 89 x 45	Módulo prolongación de armario en M.D.F. con 1 estante			
	B.VPE3W	B.VPE3N	B.VPE3A	298,98
74 x 89 x 45	Módulo prolongación de armario en M.D.F. con puertas			
	B.VPB3W	B.VPB3N	B.VPB3A	481,72
74 x 89 x 45	Módulo prolongación de armario en M.D.F. con vitrinas			
	B.VPV3W	B.VPV3N	B.VPV3A	561,88
40 x 89 x 45	Módulo prolongación (altillo)			
	B.VPA3W	B.VPA3N	B.VPA3A	246,13

No válido para parte inferior de conjunto de armarios

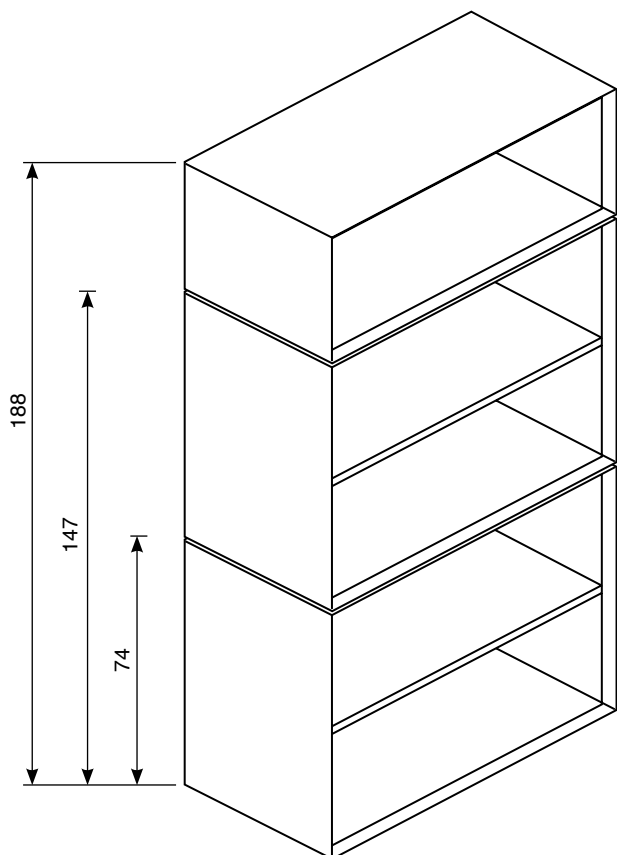

ARMARIO PROLONGACIÓN

- ALTILLO = B.VPA3 + ACABADO
- ESTANTES = B.VPE3 + ACABADO
- PUERTAS = B.VPB3 + ACABADO
- VITRINAS = B.VPV3 + ACABADO

ARMARIO INDIVIDUAL

- ESTANTES = B.VE3 + ACABADO
- PUERTAS = B.VB3 + ACABADO
- VITRINAS = B.VV3 + ACABADO
- ARCHIVO = B.VF3 + ACABADO**

**LA REF. B.VF3 (ARCHIVADOR) SOLO ES VÁLIDO COMO ARMARIO INDIVIDUAL O PARTE INFERIOR DE CONJUNTO DE ARMARIOS.





ACABADOS:
 WENGUE: **W**
 NOGAL: **N**
 ARCE: **A**

serie **BLOOGIK**

e= 60 mm. **CANTO RECTO - TABLERO ATAMBORADO**

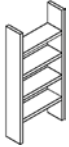
PVP

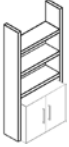
PVP

MEDIDAS alto x ancho x fondo	WENGUE	NOGAL	ARCE	€
Estantería 200 x 101 x 33 con 4 estantes y aspa metálica.				
	B.E904W	B.E904N	B.E904A	676,76
Costado prolongación de estantería 200 x 95 x 33 con 4 estantes y aspa metálica.				
	B.EP904W	B.EP904N	B.EP904A	522,33
Estantería 200 x 101 x 33 con 3 estantes y aspa metálica.				
 (1)	B.E903W	B.E903N	B.E903A	590,46
Costado prolongación de estantería 200 x 95 x 33 con 3 estantes y aspa metálica.				
 (1)	B.EP903W	B.EP903N	B.EP903A	436,04

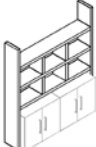
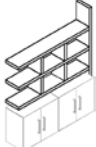
MEDIDAS alto x ancho x fondo	WENGUE	NOGAL	ARCE	€
Estantería 200 x 190 x 33 con 3 estantes				
 (1)	B.E183W	B.E183N	B.E183A	844,81
Costado prolongación de estantería 200 x 184 x 33 con 3 estantes.				
 (1)	B.EP183.W	B.EP183.N	B.EP183.A	690,39
(1) Armarios no incluidos				



serie **BLOCK**



ARMARIOS

- Estantes incorporados de 25 mm. de espesor.
- Cantos rectos de 2 mm. de grosor.
- Aristas redondeadas.
- Bisagras provistas de sistema autocierre y apertura a 110°
- Puertas de altura media y alta provistas de falleba plana.
- Archivos con guías telescópicas de extracción total con cerradura individualizada en cada cajón y llave maestra para ambos cajones.
- Tableros aglomerados de alta densidad de $\pm 750 \text{ kg/m}^3$.
- Vitrinas con cristales al ácido de 5 mm. de grosor.
- Niveladores de 1,5 cm. de regulación, regulables desde el interior.

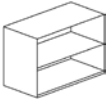
IVEN

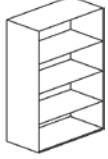
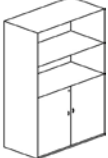
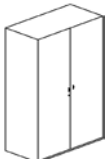
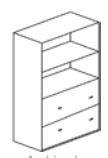
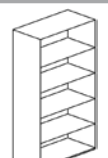
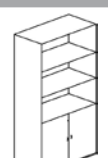
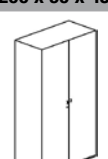

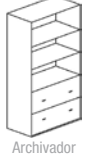

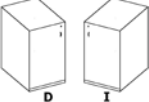
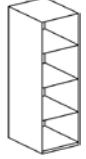
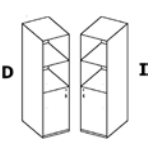
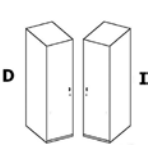
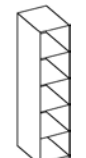
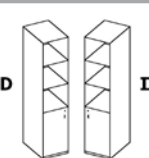
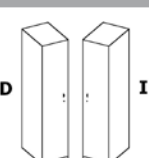
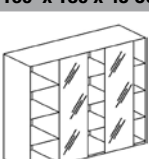

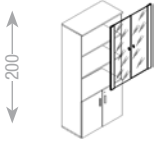
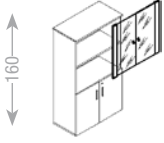
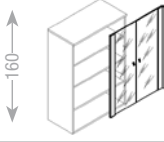
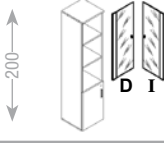
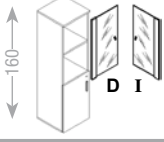
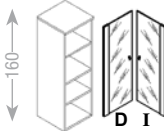



MEDIDAS alto x ancho x fondo	WENGUE	CEREZO	NOGAL	TEKA	ROBLE	€
74 x 90 x 45	CON 1 ESTANTE					
	I.VE3W	I.VE3C	I.VE3N	I.VE3T	I.VE3R	145,66
74 x 90 x 45	CON 1 ESTANTE					
	I.VB3W	I.VB3C	I.VB3N	I.VB3T	I.VB3R	227,52
74 x 90 x 45	CON 1 ESTANTE					
 Archivador	I.VF3W	I.VF3C	I.VF3N	I.VF3T	I.VF3R	409,08
160 x 90 x 45	CON 3 ESTANTES					
	I.VE2W	I.VE2C	I.VE2N	I.VE2T	I.VE2R	209,31
160 x 90 x 45	CON 3 ESTANTES					
	I.VB2W	I.VB2C	I.VB2N	I.VB2T	I.VB2R	291,18
160 x 90 x 45	CON 3 ESTANTES					
	I.VA2W	I.VA2C	I.VA2N	I.VA2T	I.VA2R	308,99
160 x 90 x 45	CON 2 ESTANTES					
 Archivador	I.VF2W	I.VF2C	I.VF2N	I.VF2T	I.VF2R	472,74
200 x 90 x 45	CON 4 ESTANTES					
	I.VEW	I.VEC	I.VEN	I.VET	I.VER	277,28
200 x 90 x 45	CON 4 ESTANTES					
	I.VBW	I.VBC	I.VBN	I.VBT	I.VBR	718,29
200 x 90 x 45	CON 4 ESTANTES					
	I.VAW	I.VAC	I.VAN	I.VAT	I.VAR	399,49



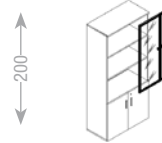
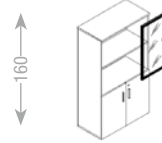
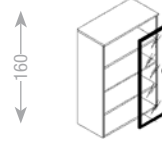
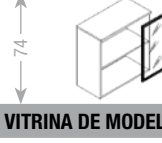

MEDIDAS alto x ancho x fondo	WENGUE	CEREZO	NOGAL	TEKA	ROBLE	€
200 x 90 x 45	CON 3 ESTANTES					
 Archivador	I.VFW	I.VFC	I.VFN	I.VFT	I.VFR	540,71
74 x 45 x 45	CON 1 ESTANTE					
	I.VE3W/5	I.VE3C/5	I.VE3N/5	I.VE3T/5	I.VE3R/5	100,08
74 x 45 x 45	CON 1 ESTANTE					
 D I	I.VB3W/5I I.VB3W/5D	I.VB3C/5I I.VB3C/5D	I.VB3N/5I I.VB3N/5D	I.VB3T/5I I.VB3T/5D	I.VB3R/5I I.VB3R/5D	144,98
160 x 45 x 45	CON 3 ESTANTES					
	I.VE2W/5	I.VE2C/5	I.VE2N/5	I.VE2T/5	I.VE2R/5	175,76
160 x 45 x 45	CON 3 ESTANTES					
 D I	I.VB2W/5I I.VB2W/5D	I.VB2C/5I I.VB2C/5D	I.VB2N/5I I.VB2N/5D	I.VB2T/5I I.VB2T/5D	I.VB2R/5I I.VB2R/5D	220,66
160 x 45 x 45	CON 3 ESTANTES					
 D I	I.VA2W/5I I.VA2W/5D	I.VA2C/5I I.VA2C/5D	I.VA2N/5I I.VA2N/5D	I.VA2T/5I I.VA2T/5D	I.VA2R/5I I.VA2R/5D	251,11
200 x 45 x 45	CON 4 ESTANTES					
	I.VEW/5	I.VEC/5	I.VEN/5	I.VET/5	I.VER/5	231,94
200 x 45 x 45	CON 4 ESTANTES					
 D I	I.VBW/5I I.VBW/5D	I.VBC/5I I.VBC/5D	I.VBN/5I I.VBN/5D	I.VBT/5I I.VBT/5D	I.VBR/5I I.VBR/5D	276,84
200 x 45 x 45	CON 4 ESTANTES					
 D I	I.VAW/5I I.VAW/5D	I.VAC/5I I.VAC/5D	I.VAN/5I I.VAN/5D	I.VAT/5I I.VAT/5D	I.VAR/5I I.VAR/5D	329,89
160 x 180 x 45	CON 2 VITRINAS DE ALUMINIO DE 45 CM.					
	A.V160W	I.V160C	A.V160N	I.V160T	A.V160R	1034,55

	WENGUE	CEREZO	NOGAL	TEKA	ROBLE	€
VITRINA DE MODELOS VB - VF (MARCOS DE MADERA)						
	I.VITBW	I.VITBC	I.VITBN	I.VITBT	I.VITBR	221,94
VITRINA DE MODELOS VB2 - VF2 (MARCOS DE MADERA)						
	I.VITB2W	I.VITB2C	I.VITB2N	I.VITB2T	I.VITB2R	177,02
VITRINA DE MODELOS VE2 (MARCO DE MADERA)						
	I.VITE2W	I.VITE2C	I.VITE2N	I.VITE2T	I.VITE2R	221,94
VITRINA DE MODELOS VB/5 (MARCO DE MADERA)						
	I.VITBW/5I	I.VITBC/5I	I.VITBN/5I	I.VITBT/5I	I.VITBR/5I	128,85
	I.VITBW/5D	I.VITBC/5D	I.VITBN/5D	I.VITBT/5D	I.VITBR/5D	
VITRINA DE MODELOS VB2/5 (MARCO DE MADERA)						
	I.VITB2W/5I	I.VITB2C/5I	I.VITB2N/5I	I.VITB2T/5I	I.VITB2R/5I	106,41
	I.VITB2W/5D	I.VITB2C/5D	I.VITB2N/5D	I.VITB2T/5D	I.VITB2R/5D	
VITRINA DE MODELOS VE2/5 (MARCOS DE MADERA)						
	I.VITE2W/5I	I.VITE2C/5I	I.VITE2N/5I	I.VITE2T/5I	I.VITE2R/5I	128,85
	I.VITE2W/5D	I.VITE2C/5D	I.VITE2N/5D	I.VITE2T/5D	I.VITE2R/5D	

	WENGUE	CEREZO	NOGAL	TEKA	ROBLE	€
ESTANTE DE ARMARIO DE 45 cm.						
	I.E45W	I.E45C	I.E45N	I.E45T	I.E45R	22,65
ESTANTE DE ARMARIO DE 90 cm.						
	I.E90W	I.E90C	I.E90N	I.E90T	I.E90R	28,63
ESTANTE ARMARIO 90 cm. PARA CARPETAS. NO VÁLIDO PARA PUERTAS CORREDERAS						
	I.BASW	I.BASC	I.BASN	I.BAST	I.BASR	34,06

ESTAS ENCIMERAS SUSTITUYEN A LAS QUE LLEVAN LOS ARMARIOS DE SERIE						
ENCIMERA PARA 2 ARMARIOS: 135 cm. = 90 cm. + 45 cm.						
	I.ENC135W	I.ENC135C	I.ENC135N	I.ENC135T	I.ENC135R	0,00
ENCIMERA PARA 2 ARMARIOS: 180 cm.= 90 cm. + 90 cm.						
	I.ENC180W	I.ENC180C	I.ENC180N	I.ENC180T	I.ENC180R	0,00
ENCIMERA PARA 3 ARMARIOS: 225 cm. = 90 cm. + 45 cm. + 90 cm.						
	I.ENC225W	I.ENC225C	I.ENC225N	I.ENC225T	I.ENC225R	0,00
ENCIMERA PARA 3 ARMARIOS: 270 cm. = 90 cm. + 90 cm. + 90 cm.						
	I.ENC270W	I.ENC270C	I.ENC270N	I.ENC270T	I.ENC270R	0,00

	ALUMINIO	€
VITRINAS CON CERRADURA		
VITRINA DE MODELOS VB - VF (MARCO DE ALUMINIO)		
	I.VITBML	332,67
VITRINA DE MODELOS VB2 - VF2 (MARCOS DE ALUMINIO)		
	I.VITB2ML	256,55
VITRINA DE MODELOS VE2 (MARCOS DE ALUMINIO)		
	I.VITE2ML	368,26
VITRINA DE MODELO VE3 (MARCOS DE ALUMINIO)		
	I.VITE3ML	256,55
VITRINA DE MODELOS VB/5 (MARCOS DE ALUMINIO)		
	I.VITBML/5I	166,33
	I.VITBML/5D	
VITRINA DE MODELOS VB2/5 (MARCOS DE ALUMINIO)		
	I.VITB2ML/5I	128,26
	I.VITB2ML/5D	
VITRINA DE MODELOS VE2/5 (MARCOS DE ALUMINIO)		
	I.VITE2ML/5I	184,14
	I.VITE2ML/5D	
VITRINA DE MODELOS VE3/5 (MARCOS DE ALUMINIO)		
	I.VITE3ML/5I	128,26
	I.VITE3ML/5D	

	WENGUE	CEREZO	NOGAL	TEKA	ROBLE	€
JUEGO DE COSTADOS TERMINALES CON ASPA. medidas: 220 x 95 x 33						
	I.ESTT.W	I.ESTT.C	I.ESTT.N	I.ESTT.T	I.ESTT.R	147,28
COSTADO INTERMEDIO CON ASPA. medidas: 220 x 92,5 x 33						
	I.ESTI.W	I.ESTI.C	I.ESTI.N	I.ESTI.T	I.ESTI.R	83,15
ESTANTE DE MÓDULO ESTANTERÍA. medidas: 90x31						
	I.EMEW	I.EMEC	I.EMEN	R.EMET	I.EMER	36,37
ESTANTE METÁLICO DE MÓDULO ESTANTERÍA, GRIS ALUMINIO. 90x31						
	I.EMET					44,25





Características Técnicas





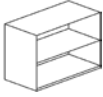

ARMARIOS

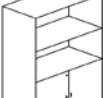
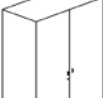
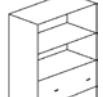
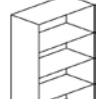
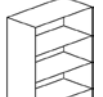
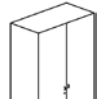
- Estantes incorporados de 22 mm. de espesor.
- Cantos rectos de 2 mm. de grosor en acabados gris, arce y wengue.
- Cantos rectos en madera de 2 mm. de grosor en acabados haya, cerezo y palisandro.
- Aristas de los cantos rectos redondeadas a los bordes.
- Puertas de altura media y alta provistas de falleba plana.
- Archivos con guías telescópicas de extracción total, con cerradura individualizada en cada cajón y llave maestra para ambos cajones.
- Tableros aglomerados de alta densidad $\pm 750 \text{ kg/m}^2$.
- Vitrinas con cristales al ácido de 5 mm. de grosor.
- Niveladores de 1,5 cm. de regulación, regulables desde el interior.

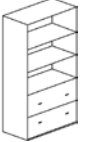
SIRIUS

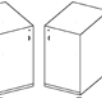

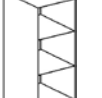
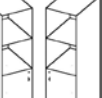
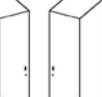
alto x ancho x fondo MEDIDAS	PALISAND.	HAYA	CEREZO	€	ARCE	WENGUE	€
74 x 90 x 45	CON 1 ESTANTE (COSTADOS Y ESTANTE EN GRIS ALUMINIO)						
	VE3GP	VE3GH	VE3GC	168,38	VE3GA	VE3GW	142,88
74 x 90 x 45	CON 1 ESTANTE (COSTADOS Y ESTANTE EN GRIS ALUMINIO)						
	VB3GP	VB3GH	VB3GC	280,95	VB3GA	VB3GW	221,20
74 x 90 x 45	(COSTADOS EN GRIS ALUMINIO)						
	VF3GP	VF3GH	VF3GC	472,89	VF3GA	VF3GW	399,18
160 x 90 x 45	CON 3 ESTANTES (COSTADOS Y ESTANTES EN GRIS ALUMINIO)						
	VE2GP	VE2GH	VE2GC	230,83	VE2GA	VE2GW	205,33
160 x 90 x 45	CON 3 ESTANTES (COSTADOS Y ESTANTES EN GRIS ALUMINIO)						
	VB2GP	VB2GH	VB2GC	283,65	VB2GA	VB2GW	283,65
160 x 90 x 45	CON 3 ESTANTES (COSTADOS Y ESTANTES EN GRIS ALUMINIO)						
	VA2GP	VA2GH	VA2GC	408,21	VA2GA	VA2GW	301,44
160 x 90 x 45	CON 2 ESTANTES (COSTADOS Y ESTANTES EN GRIS ALUMINIO)						
	VF2GP	VF2GH	VF2GC	535,34	VF2GA	VF2GW	461,63
200 x 90 x 45	CON 4 ESTANTES (COSTADOS Y ESTANTES EN GRIS ALUMINIO)						
	VEGP	VEGH	VEGC	297,49	VEGA	VEGW	271,99
200 x 90 x 45	CON 4 ESTANTES (COSTADOS Y ESTANTES EN GRIS ALUMINIO)						
	VBGP	VBGH	VBGC	410,07	VBGA	VBGW	350,31
200 x 90 x 45	CON 4 ESTANTES (COSTADOS Y ESTANTES EN GRIS ALUMINIO)						
	VAGP	VAGH	VAGC	517,81	VAGA	VAGW	390,64

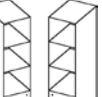
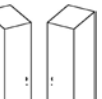
alto x ancho x fondo MEDIDAS	PALISAND.	HAYA	CEREZO	€	ARCE	WENGUE	€
200 x 90 x 45	CON 3 ESTANTES (COSTADOS Y ESTANTES EN GRIS ALUMINIO)						
 Archivador	VFGP	VFGH	VFGC	602,01	VFGA	VFGW	528,30
74 x 45 x 45	CON 1 ESTANTE (COSTADOS Y ESTANTE EN GRIS ALUMINIO)						
	VE3GP/5	VE3GH/5	VE3GC/5	118,83	VE3GA/5	VE3GW/5	98,18
74 x 45 x 45	CON 1 ESTANTE (COSTADOS Y ESTANTE EN GRIS ALUMINIO)						
	VB3GP/5I	VB3GH/5I	VB3GC/5I	187,13	VB3GA/5I	VB3GW/5I	142,23
	VB3GP/5D	VB3GH/5D	VB3GC/5D		VB3GA/5D	VB3GW/5D	
74 x 45 x 45	(COSTADOS EN GRIS ALUMINIO) *No válido para encimera corrida						
	VC3GP	VC3GH	VC3GC	320,32	VC3GA	VC3GW	265,09
160 x 45 x 45	CON 3 ESTANTES (COSTADOS Y ESTANTES EN GRIS ALUMINIO)						
	VE2GP/5	VE2GH/5	VE2GC/5	193,06	VE2GA/5	VE2GW/5	172,41
160 x 45 x 45	CON 3 ESTANTES (COSTADOS Y ESTANTES EN GRIS ALUMINIO)						
	VB2GP/5I	VB2GH/5I	VB2GC/5I	261,36	VB2GA/5I	VB2GW/5I	216,46
	VB2GP/5D	VB2GH/5D	VB2GC/5D		VB2GA/5D	VB2GW/5D	
160 x 45 x 45	CON 3 ESTANTES (COSTADOS Y ESTANTES EN GRIS ALUMINIO)						
	VA2GP/5I	VA2GH/5I	VA2GC/5I	328,41	VA2GA/5I	VA2GW/5I	246,33
	VA2GP/5D	VA2GH/5D	VA2GC/5D		VA2GA/5D	VA2GW/5D	
200 x 45 x 45	CON 4 ESTANTES (COSTADOS Y ESTANTES EN GRIS ALUMINIO)						
	VEGP/5	VEGH/5	VEGC/5	248,15	VEGA/5	VEGW/5	227,50
200 x 45 x 45	CON 4 ESTANTES (COSTADOS Y ESTANTES EN GRIS ALUMINIO)						
	VBGP/5I	VBGH/5I	VBGC/5I	316,45	VBGA/5I	VBGW/5I	271,55
	VBGP/5D	VBGH/5D	VBGC/5D		VBGA/5D	VBGW/5D	
200 x 45 x 45	CON 4 ESTANTES (COSTADOS Y ESTANTES EN GRIS ALUMINIO)						
	VAGP/5I	VAGH/5I	VAGC/5I	424,09	VAGA/5I	VAGW/5I	323,60
	VAGP/5D	VAGH/5D	VAGC/5D		VAGA/5D	VAGW/5D	

	ACABADO MADERA			PVP	ACABADO ESTRATIFICADO			PVP
	PALISAND.	HAYA	CEREZO	€	ARCE	WENGUE	€	
VITRINAS PARA MODELOS VB2 - VF2 (MARCO DE MADERA)								
	VIT.P3	VIT.H3	VIT.C3	182,36	VIT.A3	VIT.W3	177,02	
VITRINA PARA MODELOS VE2 (MARCO DE MADERA)								
	VIT.P2	VIT.H2	VIT.C2	228,59	VIT.A2	VIT.W2	221,94	
VITRINA PARA MODELOS VB - VF (MARCO DE MADERA)								
	VIT.P4	VIT.H4	VIT.C4	228,59	VIT.A4	VIT.W4	221,94	
VITRINA PARA MODELOS VB2/5 (MARCO DE MADERA)								
	VIT.P3/5I	VIT.H3/5I	VIT.C3/5I	109,60	VIT.A3/5I	VIT.W3/5I	106,41	
	VIT.P3/5D	VIT.H3/5D	VIT.C3/5D		VIT.A3/5D	VIT.W3/5D		
VITRINA PARA MODELOS VE2/5 (MARCO DE MADERA)								
	VIT.P2/5I	VIT.H2/5I	VIT.C2/5I	132,71	VIT.A2/5I	VIT.W2/5I	128,85	
	VIT.P2/5D	VIT.H2/5D	VIT.C2/5D		VIT.A2/5D	VIT.W2/5D		
VITRINA PARA MODELOS VB/5 (MARCO DE MADERA)								
	VIT.P4/5I	VIT.H4/5I	VIT.C4/5I	132,71	VIT.A4/5I	VIT.W4/5I	128,85	
	VIT.P4/5D	VIT.H4/5D	VIT.C4/5D		VIT.A4/5D	VIT.W4/5D		
ESTANTE ENTRE ARMARIOS (89 cm.)								
	EP.S	EH.S	EC.S	58,29	EA.S	EW.S	36,37	
ESTANTE GRIS DE ARMARIOS DE 90 cm. PARA CARPETAS								
	BASG.S						34,06	

	ACABADO MADERA			PVP	ACABADO ESTRATIFICADO			PVP
	PALISAND.	HAYA	CEREZO	€	ARCE	WENGUE	€	
ESTAS ENCIMERAS SUSTITUYEN A LAS QUE LLEVAN LOS ARMARIOS DE SERIE								
ENCIMERA PARA 2 ARMARIOS: 135cm = 90 cm. + 45 cm.								
	S.ENC135P	A.ENC135H	A.ENC135C	0,00	S.ENC135A	I.ENC135W	0,00	
ENCIMERA PARA 2 ARMARIOS: 180cm = 90cm + 90cm								
	S.ENC180P	A.ENC180H	A.ENC180C	0,00	S.ENC180A	I.ENC180W	0,00	
ENCIMERA PARA 3 ARMARIOS: 225cm = 90cm + 45cm + 90cm								
	S.ENC225P	A.ENC225H	A.ENC225C	0,00	S.ENC225A	I.ENC225W	0,00	
ENCIMERA PARA 3 ARMARIOS: 270 cm = 90cm + 90cm + 90 cm								
	-	-	-	-	S.ENC270A	I.ENC270W	0,00	

	ALUMINIO		€
VITRINAS CON CERRADURA			
VITRINA MOD. VB2-VF2 (MARCO ALUMINIO)			
	VIT.ML3		256,55
VITRINA MOD. VE2 (MARCO ALUMINIO)			
	VIT.ML2		368,26
VITRINA MOD. VB - VF (MARCO ALUMINIO)			
	VIT.ML4		332,67
VITRINA MOD. VE3 (MARCO ALUMINIO)			
	VIT.ML5		256,55
VITRINA MOD. VB2/5 (MARCO ALUMINIO)			
	VIT.ML3/5I		128,26
	VIT.ML3/5D		
VITRINA MOD. VE2/5 (MARCO ALUMINIO)			
	VIT.ML2/5I		184,14
	VIT.ML2/5D		
VITRINA MOD. VB/5 (MARCO ALUMINIO)			
	VIT.ML4/5I		166,33
	VIT.ML4/5D		
VITRINA MOD. VE3/5 (MARCO ALUMINIO)			
	VIT.ML5/5I		128,26
	VIT.ML5/5D		
ESTANTE GRIS DE ARMARIO DE 90cm.			
	EG.S		28,29
ESTANTE GRIS DE ARMARIO DE 45cm.			
	EG45.S		22,43

Características Técnicas

ARMARIOS APILABLES

- Posibilidad de modular la altura de los armarios mediante el uso de bloques de 40 cm. de alto, hasta alcanzar la altura del techo.
- Puertas con sistema "push to open®", que evita el uso de tiradores.
- Niveladores de 1,5 cm. de regulación, regulables desde el interior.



















Armarios











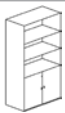
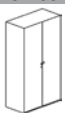



T5



R3

M4



H2

medidas: alto x ancho x fondo	ACABADO CARCASA	WENGUE Canto Wengue	NOGAL Canto Alistonado	GEREZO Canto Alistonado	TEKA Canto Tekka	HAYA Canto Haya	ARCE Canto Arce	ROBLE Canto Alistonado	BLANCO Canto Blanco	€
74 x 90 x 45 - con 1 estante			NUEVO	NUEVO				NUEVO		
	Unicolor Bicolor (Gris Aluminio)	R.VE3W R.VE3LW	R.VE3N R.VE3LN	R.VE3C R.VE3LC	R.VE3T R.VE3LT	R.VE3H R.VE3LH	R.VE3A R.VE3LA	R.VE3R R.VE3LR	R.VE3B R.VE3LB	115,61
74 x 90 x 45 - con 1 estante										
Puertas batientes 	Unicolor Bicolor (Gris Aluminio)	R.VB3W R.VB3LW	R.VB3N R.VB3LN	R.VB3C R.VB3LC	R.VB3T R.VB3LT	R.VB3H R.VB3LH	R.VB3A R.VB3LA	R.VB3R R.VB3LR	R.VB3B R.VB3LB	176,13
74 x 90 x 45										
Archivador 	Unicolor Bicolor (Gris Aluminio)	R.VF3W R.VF3LW	R.VF3N R.VF3LN	R.VF3C R.VF3LC	R.VF3T R.VF3LT	R.VF3H R.VF3LH	R.VF3A R.VF3LA	R.VF3R R.VF3LR	R.VF3B R.VF3LB	336,31
74 x 90 x 45 - con 1 estante										
Puertas correderas 	Unicolor Bicolor (Gris Aluminio)	R.VC3W R.VC3LW	R.VC3N R.VC3LN	R.VC3C R.VC3LC	R.VC3T R.VC3LT	R.VC3H R.VC3LH	R.VC3A R.VC3LA	R.VC3R R.VC3LR	R.VC3B R.VC3LB	240,40
74 x 90 x 90- con 1 estante										
 NUEVO	Unicolor Bicolor (Gris Aluminio)	R.VEX3W R.VEX3LW	R.VEX3N R.VEX3LN	R.VEX3C R.VEX3LC	R.VEX3T R.VEX3LT	R.VEX3H R.VEX3LH	R.VEX3A R.VEX3LA	R.VEX3R R.VEX3LR	R.VEX3B R.VEX3LB	221,22
87 x 90 x 45 - con 1 estante - Para 2 filas AZ										
	Unicolor Bicolor (Gris Aluminio)	R.VEAZW R.VEAZLW	R.VEAZN R.VEAZLN	R.VEAZC R.VEAZLC	R.VEAZT R.VEAZLT	R.VEAZH R.VEAZLH	R.VEAZA R.VEAZLA	R.VEAZR R.VEAZLR	R.VEAZB R.VEAZLB	175,43
87 x 90 x 45 - con 1 estante - Para 2 filas AZ										
Puertas batientes 	Unicolor Bicolor (Gris Aluminio)	R.VBAZW R.VBAZLW	R.VBAZN R.VBAZLN	R.VBAZC R.VBAZLC	R.VBAZT R.VBAZLT	R.VBAZH R.VBAZLH	R.VBAZA R.VBAZLA	R.VBAZR R.VBAZLR	R.VBAZB R.VBAZLB	236,50
87 x 90 x 90- con 1 estante - Para 2 filas AZ										
 NUEVO	Unicolor Bicolor (Gris Aluminio)	R.VEXAZW R.VEXAZLW	R.VEXAZN R.VEXAZLN	R.VEXAZC R.VEXAZLC	R.VEXAZT R.VEXAZLT	R.VEXAZH R.VEXAZLH	R.VEXAZA R.VEXAZLA	R.VEXAZR R.VEXAZLR	R.VEXAZB R.VEXAZLB	350,87
160 x 90 x 45 - con 3 estantes										
	Unicolor Bicolor (Gris Aluminio)	R.VE2W R.VE2LW	R.VE2N R.VE2LN	R.VE2C R.VE2LC	R.VE2T R.VE2LT	R.VE2H R.VE2LH	R.VE2A R.VE2LA	R.VE2R R.VE2LR	R.VE2B R.VE2LB	180,36
160 x 90 x 45 - con 3 estantes										
Puertas batientes 	Unicolor Bicolor (Gris Aluminio)	R.VB2W R.VB2LW	R.VB2N R.VB2LN	R.VB2C R.VB2LC	R.VB2T R.VB2LT	R.VB2H R.VB2LH	R.VB2A R.VB2LA	R.VB2R R.VB2LR	R.VB2B R.VB2LB	240,89
160 x 90 x 45 - con 3 estantes										
Puertas batientes 	Unicolor Bicolor (Gris Aluminio)	R.VA2W R.VA2LW	R.VA2N R.VA2LN	R.VA2C R.VA2LC	R.VA2T R.VA2LT	R.VA2H R.VA2LH	R.VA2A R.VA2LA	R.VA2R R.VA2LR	R.VA2B R.VA2LB	258,68
160 x 90 x 45 - con 2 estantes										
Archivador 	Unicolor Bicolor (Gris Aluminio)	R.VF2W R.VF2LW	R.VF2N R.VF2LN	R.VF2C R.VF2LC	R.VF2T R.VF2LT	R.VF2H R.VF2LH	R.VF2A R.VF2LA	R.VF2R R.VF2LR	R.VF2B R.VF2LB	401,07
160 x 90 x 45 - con 3 estantes										
Puertas correderas 	Unicolor Bicolor (Gris Aluminio)	R.VC2W R.VC2LW	R.VC2N R.VC2LN	R.VC2C R.VC2LC	R.VC2T R.VC2LT	R.VC2H R.VC2LH	R.VC2A R.VC2LA	R.VC2R R.VC2LR	R.VC2B R.VC2LB	305,15
160 x 90 x 90- con 3 estante										
 NUEVO	Unicolor Bicolor (Gris Aluminio)	R.VEX2W R.VEX2LW	R.VEX2N R.VEX2LN	R.VEX2C R.VEX2LC	R.VEX2T R.VEX2LT	R.VEX2H R.VEX2LH	R.VEX2A R.VEX2LA	R.VEX2R R.VEX2LR	R.VEX2B R.VEX2LB	360,72
100 x 180 x 45 - con 2 vitrinas de aluminio de 45 cm.										
	Unicolor	R.V100W	R.V100N	R.V100C	R.V100T	R.V100H	R.V100A	R.V100R	R.V100B	746,99
160 x 180 x 45 - con 2 vitrinas de aluminio de 45 cm.										
	Unicolor	R.V160W	A.V160N	I.V160C	R.V160T	R.V160H	R.V160A	A.V160R	R.V160B	1034,55

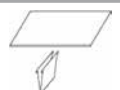
medidas: alto x ancho x fondo	ACABADO CARCASA	WENGUE Canto Wengue	NOGAL Canto Alistonado	CEREZO Canto Alistonado	TEKA Canto Tekka	HAYA Canto Haya	ARCE Canto Arce	ROBLE Canto Alistonado	BLANCO Canto Blanco	€
200 x 90 x 45 - con 4 estantes										
	Unicolor	R.VEW	R.VEN	R.VEC	R.VET	R.VEH	R.VEA	R.VER	R.VEB	229,01
	Bicolor (Gris Aluminio)	R.VELW	R.VELN	R.VELC	R.VELT	R.VELH	R.VELA	R.VELR	R.VELB	
200 x 90 x 45 - con 4 estantes										
	Unicolor	R.VBW	R.VBN	R.VBC	R.VBT	R.VBH	R.VBA	R.VBR	R.VBB	289,53
Puertas batientes	Bicolor (Gris Aluminio)	R.VBLW	R.VBLN	R.VBLC	R.VBLT	R.VBLH	R.VBLA	R.VBLR	R.VBLB	
200 x 90 x 45 - con 4 estantes										
	Unicolor	R.VAW	R.VAN	R.VAC	R.VAT	R.VAH	R.VAA	R.VAR	R.VAB	329,88
Puertas batientes	Bicolor (Gris Aluminio)	R.VALW	R.VALN	R.VALC	R.VALT	R.VALH	R.VALA	R.VALR	R.VALB	
200 x 90 x 45 - con 3 estantes										
	Unicolor	R.VFW	R.VFN	R.VFC	R.VFT	R.VFH	R.VFA	R.VFR	R.VFB	449,72
Archivador	Bicolor (Gris Aluminio)	R.VFLW	R.VFLN	R.VFLC	R.VFLT	R.VFLH	R.VFLA	R.VFLR	R.VFLB	
200 x 90 x 45 - con 4 estantes										
	Unicolor	R.VCW	R.VCN	R.VCC	R.VCT	R.VCH	R.VCA	R.VCR	R.VCB	353,80
Puertas correderas	Bicolor (Gris Aluminio)	R.VCLW	R.VCLN	R.VCLC	R.VCLT	R.VCLH	R.VCLA	R.VCLR	R.VCLB	
200 x 90 x 90 - con 4 estantes										
	Unicolor	R.VEXW	R.VEXN	R.VEXC	R.VEXT	R.VEXH	R.VEXA	R.VEX3R	R.VEXB	458,03
NUEVO	Bicolor (Gris Aluminio)	R.VEXLW	R.VEXLN	R.VEXLC	R.VEXLT	R.VEXLH	R.VEXLA	R.VEX3LR	R.VEXLB	
74 x 45 x 45 - con 1 estante										
	Unicolor	R.VE3W/5	R.VE3N/5	R.VE3C/5	R.VE3T/5	R.VE3H/5	R.VE3A/5	R.VE3R/5	R.VE3B/5	77,84
	Bicolor (Gris Aluminio)	R.VE3LW/5	R.VE3LN/5	R.VE3LC/5	R.VE3LT/5	R.VE3LH/5	R.VE3LA/5	R.VE3LR/5	R.VE3LB/5	
74 x 45 x 45 - con 1 estante										
	Unicolor	R.VB3W/5I	R.VB3N/5I	R.VB3C/5I	R.VB3T/5I	R.VB3H/5I	R.VB3A/5I	R.VB3R/5I	R.VB3B/5I	120,04
D I	Bicolor (Gris Aluminio)	R.VB3W/5D R.VB3LW/5I R.VB3LW/5D	R.VB3N/5D R.VB3LN/5I R.VB3LN/5D	R.VB3C/5D R.VB3LC/5I R.VB3LC/5D	R.VB3T/5D R.VB3LT/5I R.VB3LT/5D	R.VB3H/5D R.VB3LH/5I R.VB3LH/5D	R.VB3A/5D R.VB3LA/5I R.VB3LA/5D	R.VB3R/5D R.VB3LR/5I R.VB3LR/5D	R.VB3B/5D R.VB3BL/5I R.VB3BL/5D	
87 x 45 x 45 - con 1 estante - Para 2 filas de AZ.										
	Unicolor	R.VEAZW/5	R.VEAZN/5	R.VEAZC/5	R.VEAZT/5	R.VEAZH/5	R.VEAZA/5	R.VEAZR/5	R.VEAZB/5	144,38
	Bicolor (Gris Aluminio)	R.VEAZLW/5	R.VEAZLN/5	R.VEAZLC/5	R.VEAZLT/5	R.VEAZLH/5	R.VEAZLA/5	R.VEAZLR/5	R.VEAZLB/5	
87 x 45 x 45 - con 1 estante - Para 2 filas de AZ.										
	Unicolor	R.VBAZW/5I	R.VBAZN/5I	R.VBAZC/5I	R.VBAZT/5I	R.VBAZH/5I	R.VBAZA/5I	R.VBAZR/5I	R.VBAZB/5I	196,13
D I	Bicolor (Gris Aluminio)	R.VBAZW/5D R.VBAZLW/5I R.VBAZLW/5D	R.VBAZN/5D R.VBAZLN/5I R.VBAZLN/5D	R.VBAZC/5D R.VBAZLC/5I R.VBAZLC/5D	R.VBAZT/5D R.VBAZLT/5I R.VBAZLT/5D	R.VBAZH/5D R.VBAZLH/5I R.VBAZLH/5D	R.VBAZA/5D R.VBAZLA/5I R.VBAZLA/5D	R.VBAZR/5D R.VBAZLR/5I R.VBAZLR/5D	R.VBAZB/5D R.VBAZBL/5I R.VBAZBL/5D	
160 x 45 x 45 - con 3 estantes										
	Unicolor	R.VE2W/5	R.VE2N/5	R.VE2C/5	R.VE2T/5	R.VE2H/5	R.VE2A/5	R.VE2R/5	R.VE2B/5	157,32
	Bicolor (Gris Aluminio)	R.VE2LW/5	R.VE2LN/5	R.VE2LC/5	R.VE2LT/5	R.VE2LH/5	R.VE2LA/5	R.VE2LR/5	R.VE2LB/5	
160 x 45 x 45 - con 3 estantes										
	Unicolor	R.VB2W/5I	R.VB2N/5I	R.VB2C/5I	R.VB2T/5I	R.VB2H/5I	R.VB2A/5I	R.VB2R/5I	R.VB2B/5I	199,52
D I	Bicolor (Gris Aluminio)	R.VB2W/5D R.VB2LW/5I R.VB2LW/5D	R.VB2N/5D R.VB2LN/5I R.VB2LN/5D	R.VB2C/5D R.VB2LC/5I R.VB2LC/5D	R.VB2T/5D R.VB2LT/5I R.VB2LT/5D	R.VB2H/5D R.VB2LH/5I R.VB2LH/5D	R.VB2A/5D R.VB2LA/5I R.VB2LA/5D	R.VB2R/5D R.VB2LR/5I R.VB2LR/5D	R.VB2B/5D R.VB2BL/5I R.VB2BL/5D	
160 x 45 x 45 - con 3 estantes										
	Unicolor	R.VA2W/5I	R.VA2N/5I	R.VA2C/5I	R.VA2T/5I	R.VA2H/5I	R.VA2A/5I	R.VA2R/5I	R.VA2B/5I	216,66
D I	Bicolor (Gris Aluminio)	R.VA2W/5D R.VA2LW/5I R.VA2LW/5D	R.VA2N/5D R.VA2LN/5I R.VA2LN/5D	R.VA2C/5D R.VA2LC/5I R.VA2LC/5D	R.VA2T/5D R.VA2LT/5I R.VA2LT/5D	R.VA2H/5D R.VA2LH/5I R.VA2LH/5D	R.VA2A/5D R.VA2LA/5I R.VA2LA/5D	R.VA2R/5D R.VA2LR/5I R.VA2LR/5D	R.VA2B/5D R.VA2BL/5I R.VA2BL/5D	
200 x 45 x 45 - con 4 estantes										
	Unicolor	R.VEW/5	R.VEN/5	R.VEC/5	R.VET/5	R.VEH/5	R.VEA/5	R.VER/5	R.VEB/5	168,59
	Bicolor (Gris Aluminio)	R.VELW/5	R.VELN/5	R.VELC/5	R.VELT/5	R.VELH/5	R.VELA/5	R.VELR/5	R.VELB/5	
200 x 45 x 45 - con 4 estantes										
	Unicolor	R.VBW/5I	R.VBN/5I	R.VBC/5I	R.VBT/5I	R.VBH/5I	R.VBA/5I	R.VBR/5I	R.VBB/5I	210,79
D I	Bicolor (Gris Aluminio)	R.VBW/5D R.VBLW/5I R.VBLW/5D	R.VBN/5D R.VBLN/5I R.VBLN/5D	R.VBC/5D R.VBLC/5I R.VBLC/5D	R.VBT/5D R.VBLT/5I R.VBLT/5D	R.VBH/5D R.VBLH/5I R.VBLH/5D	R.VBA/5D R.VBLA/5I R.VBLA/5D	R.VBR/5D R.VBLR/5I R.VBLR/5D	R.VBB/5D R.VBLB/5I R.VBLB/5D	
200 x 45 x 45 - con 4 estantes										
	Unicolor	R.VAW/5I	R.VAN/5I	R.VAC/5I	R.VAT/5I	R.VAH/5I	R.VAA/5I	R.VAR/5I	R.VAB/5I	251,65
D I	Bicolor (Gris Aluminio)	R.VAW/5D R.VALW/5I R.VALW/5D	R.VAN/5D R.VALN/5I R.VALN/5D	R.VAC/5D R.VALC/5I R.VALC/5D	R.VAT/5D R.VALT/5I R.VALT/5D	R.VAH/5D R.VALH/5I R.VALH/5D	R.VAA/5D R.VALA/5I R.VALA/5D	R.VAR/5D R.VALR/5I R.VALR/5D	R.VAB/5D R.VALB/5I R.VALB/5D	





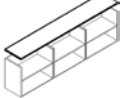



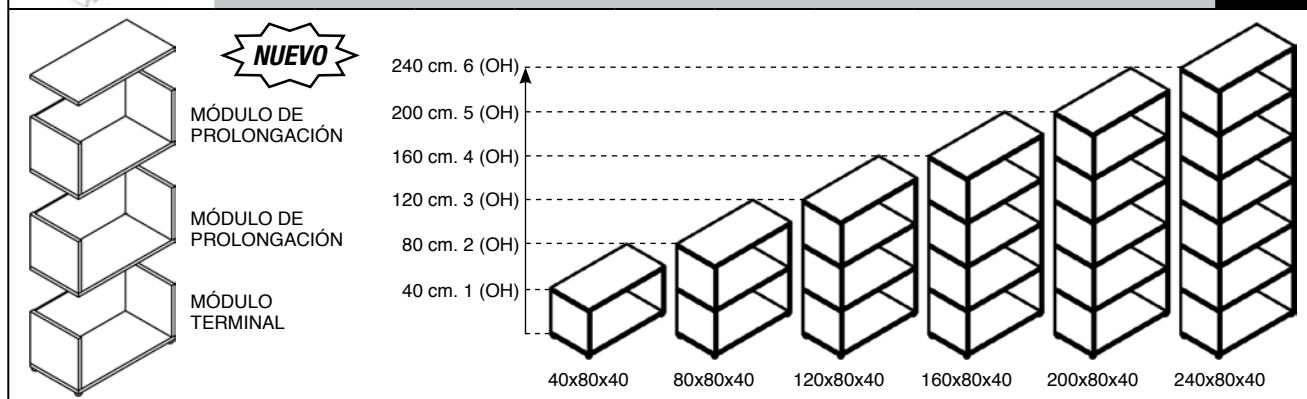











	WENGUE Canto Wengue	NOGAL Canto Alistonado	CEREZO Canto Alistonado	TEKA Canto Tekka	HAYA Canto Haya	ARCE Canto Arce	ROBLE Canto Alistonado	BLANCO Canto Blanco	€
ESTANTES									
ESTANTE DE ARMARIO DE 45 cm.									
	I.E45W	I.E45N	I.E45C	R.E45T	R.E45H	R.E45A	I.E45R	R.E45B	22,65
ESTANTE DE ARMARIO DE 90 cm.									
	I.E90W	I.E90N	I.E90C	R.E90T	R.E90H	R.E90A	I.E90R	R.E90B	28,63
ESTANTE DE ARMARIO DE 90 cm., PARA CARPETAS									
	I.BASW	I.BASN	I.BASC	R.BAST	R.BASH	R.BASA	I.BASR	R.BASB	34,06

ESTAS ENCIMERAS SUSTITUYEN A LAS QUE LLEVAN LOS ARMARIOS DE SERIE

ENCIMERA PARA 2 ARMARIOS: 135 cm. = 90 cm. + 45 cm.									
	R.ENC135W	I.ENC135N	I.ENC135C	R.ENC135T	R.ENC135H	R.ENC135A	I.ENC135R	R.ENC135B	0,00
ENCIMERA PARA 2 ARMARIOS: 180 cm. = 90 cm. + 90 cm.									
	R.ENC180W	I.ENC180N	I.ENC180C	R.ENC180T	R.ENC180H	R.ENC180A	I.ENC180R	R.ENC180B	0,00
ENCIMERA PARA 3 ARMARIOS: 225 cm. = 90 cm. + 45 cm. + 90 cm.									
	R.ENC225W	I.ENC225N	I.ENC225C	R.ENC225T	R.ENC225H	R.ENC225A	I.ENC225R	R.ENC225B	0,00
ENCIMERA PARA 3 ARMARIOS: 270 cm. = 90 cm. + 90 cm. + 90 cm.									
	R.ENC270W	I.ENC270N	I.ENC270C	R.ENC270T	R.ENC270H	R.ENC270A	I.ENC270R	R.ENC270B	0,00

	WENGUE Canto Wengue	NOGAL Canto Alistonado	CEREZO Canto Alistonado	TEKA Canto Tekka	HAYA Canto Haya	ARCE Canto Arce	ROBLE Canto Alistonado	BLANCO Canto Blanco	GRIS ALUM. Canto Gris Aluminio	€	
ARMARIOS APILABLES											
MODULO DE PROLONGACIÓN											
	40 x 80 x 40	T.VPW	T.VPN	T.VPC	T.VPT	T.VPH	T.VPA	T.VPR	T.VPB	T.VPL	67,22
MODULO TERMINAL CON ENCIMERA											
	40 x 80 x 40	T.VTW	T.VTN	T.VTC	T.VTT	T.VTH	T.VTA	T.VTR	T.VTB	T.VTL	95,11
JUEGO DE PUERTAS CON PULSADOR											
	40 x 40	T.PW	T.PN	T.PC	T.PT	T.PH	T.PA	T.PR	T.PB	T.PL	49,12
CONJUNTO DE 2 GUIAS PARA CARPETAS COLGANTES CON VISOR LATERAL											
	T.BAS									14,9	



	WENGUE Canto Wengue	NOGAL Canto Alistonado	CEREZO Canto Alistonado	TEKA Canto Tekka	HAYA Canto Haya	ARCE Canto Arce	ROBLE Canto Alistonado	BLANCO Canto Blanco	€
ESTANTERIAS									
JUEGO DE COSTADOS TERMINALES CON ASPA, medidas: 220 x 95 x 33									
	I.ESTT.W	I.ESTT.N	I.ESTT.C	I.ESTT.T	R.ESTT.H	R.ESTT.A	I.ESTT.R	R.ESTT.B	147,28
COSTADO INTERMEDIO CON ASPA, medidas: 220 x 92,5 x 33									
	I.ESTI.W	I.ESTI.N	I.ESTI.C	I.ESTI.T	R.ESTI.H	R.ESTI.A	I.ESTI.R	R.ESTI.B	83,15
ESTANTE DE MÓDULO ESTANTERÍA, medidas: 90x31									
	I.EMEW	I.EMEN	I.EMEC	R.EMET	R.EMEH	R.EMEA	I.EMER	R.EMEB	36,37
ESTANTE METÁLICO DE MÓDULO ESTANTERÍA, GRIS ALUMINIO. 90x31									
	I.EMET								44,25
VITRINAS CON MARCO DE MADERA									
VITRINA DE MODELOS VB - VF - VC (MARCOS DE MADERA)									
	I.VITBW	I.VITBN	I.VITBC	R.VITBT	R.VITBH	R.VITBA	I.VITBR	R.VITBB	221,94
VITRINA DE MODELOS VB2 - VF2 - VC2 (MARCOS DE MADERA)									
	I.VITB2W	I.VITB2N	I.VITB2C	R.VITB2T	R.VITB2H	R.VITB2A	I.VITB2R	R.VITB2B	177,02
VITRINA DE MODELOS VE2 (MARCOS DE MADERA)									
	I.VITE2W	I.VITE2N	I.VITE2C	R.VITE2T	R.VITE2H	R.VITE2A	I.VITE2R	R.VITE2B	221,94
VITRINA DE MODELOS VE3 (MARCOS DE MADERA)									
	I.VITE3W	I.VITE3N	I.VITE3C	R.VITE3T	R.VITE3H	R.VITE3A	I.VITE3R	R.VITE3B	177,02
VITRINA DE MODELOS VB/5 (MARCO DE MADERA)									
	I.VITBW/5I	I.VITBN/5I	I.VITBC/5I	R.VITBT/5I	R.VITBH/5I	R.VITBA/5I	I.VITBR/5I	R.VITBB/5I	128,85
	I.VITBW/5D	I.VITBN/5D	I.VITBC/5D	R.VITBT/5D	R.VITBH/5D	R.VITBA/5D	I.VITBR/5D	R.VITBB/5D	
VITRINA DE MODELOS VB2/5 (MARCO DE MADERA)									
	I.VITB2W/5I	I.VITB2N/5I	I.VITB2C/5I	R.VITB2T/5I	R.VITB2H/5I	R.VITB2A/5I	I.VITB2R/5I	R.VITB2B/5I	106,41
	I.VITB2W/5D	I.VITB2N/5D	I.VITB2C/5D	R.VITB2T/5D	R.VITB2H/5D	R.VITB2A/5D	I.VITB2R/5D	R.VITB2B/5D	
VITRINA DE MODELOS VE2/5 (MARCOS DE MADERA)									
	I.VITE2W/5I	I.VITE2N/5I	I.VITE2C/5I	R.VITE2T/5I	R.VITE2H/5I	R.VITE2A/5I	I.VITE2R/5I	R.VITE2B/5I	128,85
	I.VITE2W/5D	I.VITE2N/5D	I.VITE2C/5D	R.VITE2T/5D	R.VITE2H/5D	R.VITE2A/5D	I.VITE2R/5D	R.VITE2B/5D	
VITRINA DE MODELOS VE3/5 (MARCOS DE MADERA)									
	I.VITE3W/5I	I.VITE3N/5I	I.VITE3C/5I	R.VITE3T/5I	R.VITE3H/5I	R.VITE3A/5I	I.VITE3R/5I	R.VITE3B/5I	106,41
	I.VITE3W/5D	I.VITE3N/5D	I.VITE3C/5D	R.VITE3T/5D	R.VITE3H/5D	R.VITE3A/5D	I.VITE3R/5D	R.VITE3B/5D	
VITRINAS CON MARCO DE ALUMINIO CON CERRADURA									
VITRINA DE MODELOS VB - VF - VC (MARCOS DE ALUMINIO)									
	I.VITBML								332,67
VITRINA DE MODELOS VB2 - VF2 - VC2 (MARCOS DE ALUMINIO)									
	I.VITB2ML								256,55
VITRINA DE MODELOS VE2 (MARCOS DE ALUMINIO)									
	I.VITE2ML								368,26
VITRINA DE MODELOS VE3 (MARCOS DE ALUMINIO)									
	I.VITE3ML								256,55
VITRINA DE MODELOS VB/5 (MARCOS DE ALUMINIO)									
	I.VITBML/5I								166,33
	I.VITBML/5D								
VITRINA DE MODELOS VB2/5 (MARCOS DE ALUMINIO)									
	I.VITB2ML/5I								128,26
	I.VITB2ML/5D								
VITRINA DE MODELOS VE2/5 (MARCOS DE ALUMINIO)									
	I.VITE2ML/5I								184,14
	I.VITE2ML/5D								
VITRINA DE MODELOS VE3/5 (MARCOS DE ALUMINIO)									
	I.VITE3ML/5I								128,26
	I.VITE3ML/5D								